



SP6013A

Synchronous Rectifier Driver

DESCRIPTION

The fundamental of SP6013A synchronous rectifier (SR) driver IC is based on our U.S. patented methods that utilize the principle of “prediction” logic circuit. The IC deliberates previous cycle timing to control the SR in present cycle by “predictive” algorithm that makes adjustments to the turn-off time, in order to achieve maximum efficiency and avoid cross-conduction at the same time. It also maintains the MOSFET’s body diode conduction at minimum level. The SP6013A is capable to adapt in almost all existing flyback converters with few adjustments considered necessary.

FEATURES

- Offers efficiency improvement over Schottky Diode (depends on drive configuration of the SR).
- Drives all logic level Power MOSFET.
- Prediction gate timing control.
- Minimum MOSFET body diode conduction.
- Operating frequency up to 650 KHz.
- Synchronize to transformer secondary voltage waveform.

APPLICATIONS

- Servers & workstations
- Storage area network power supplies
- Telecommunication converters
- Embedded systems
- Industrial & commercial systems using high current processors

PIN CONFIGURATION (SOP-8)

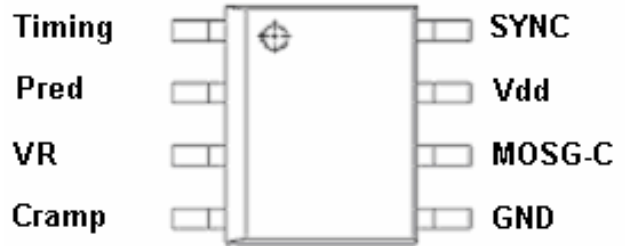

PART MARKING

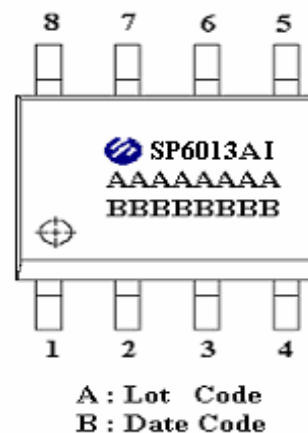



SP6013A

Synchronous Rectifier Driver

TYPICAL APPLICATION CIRCUIT

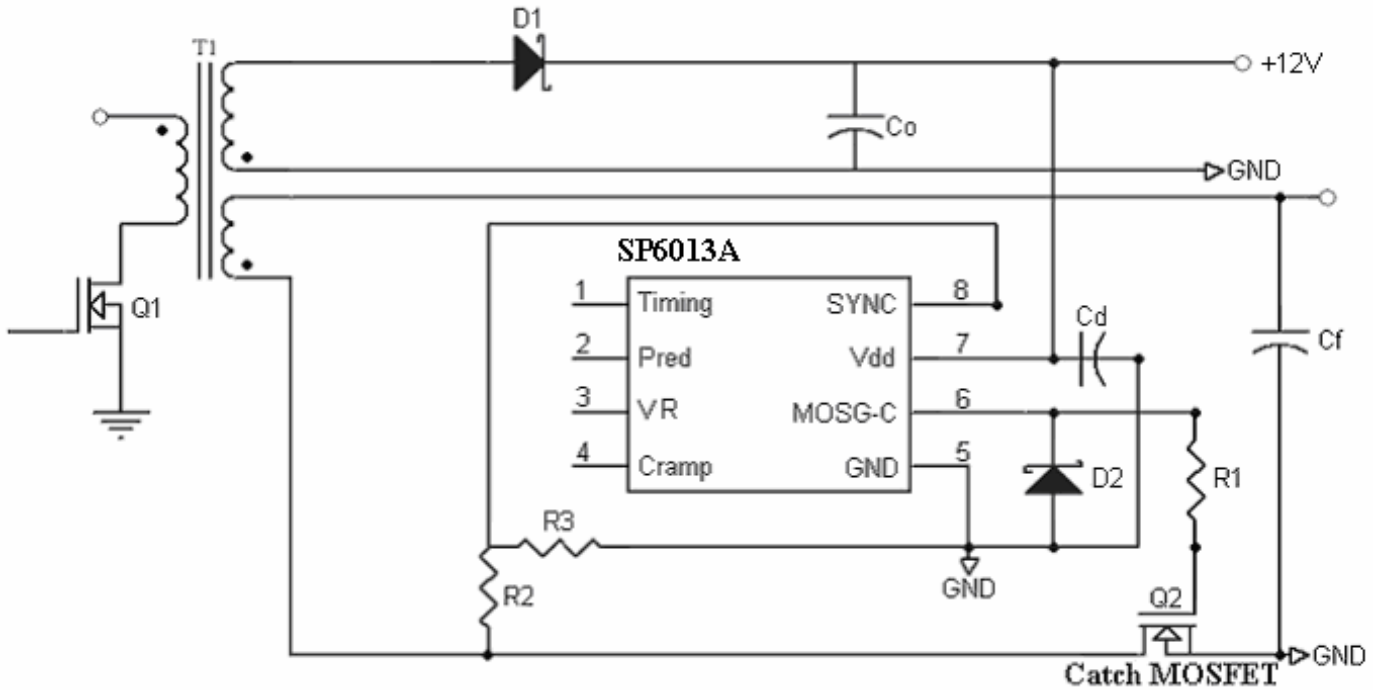

PIN DESCRIPTION

Pin	Symbol	Description
1	Timing	Discontinuous current filter timing adjustment resistor connection.
2	Pred	Capacitor to store previous cycle timing for Catch MOSFET
3	VR	Voltage Regulator
4	Cramp	Ramp capacitor adjustment to extend MOSFET's gate timing.
5	GND	Ground connection.
6	MOSG-C	Catch MOSFET gate drive.
7	Vdd	DC supply voltage.
8	SYNC	Synchronized signal from transformer's output.



SP6013A

Synchronous Rectifier Driver

BLOCK DIAGRAM

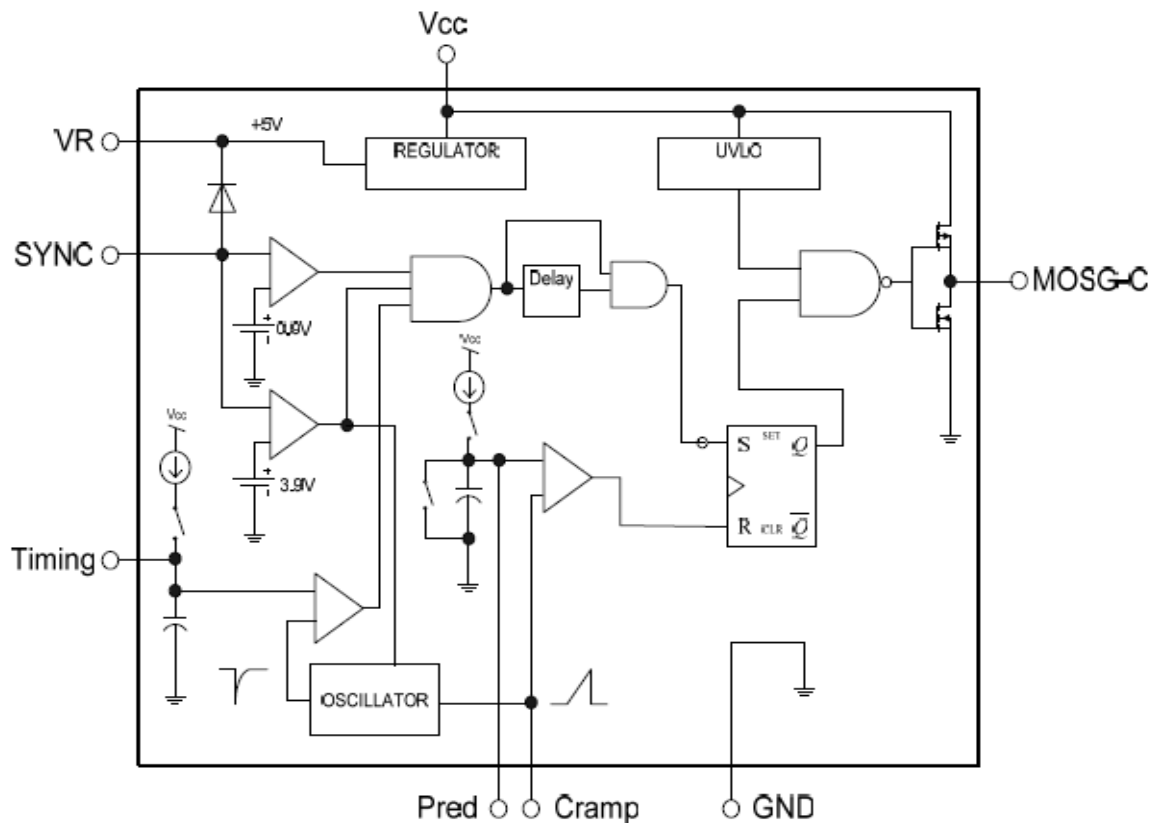

ORDERING INFORMATION

Part Number	Package	Part Marking
SP6013AS8RG	SOP-8	SP6013AI
SP6013AS8TG	SOP-8	SP6013AI

※ SP6013AS8RG : 7" Tape Reel ; Pb – Free

※ SP6013AS8TG : Tube ; Pb – Free

ABSOLUTE MAXIMUM RATINGS (TA=25°C, unless otherwise specified.)

The following ratings designate persistent limits beyond which damage to the device may occur.

Symbol	Parameter	Value	Unit
V _{dd}	DC Supply Voltage	17	V
SYNC	SYNC Voltage	7	V
I _{OUT}	Peak Source Current (Pulsed)	3	A
	Peak Sink Current (Pulsed)	3	A
P _D	Power Dissipation @ T _A =85°C (*)	0.25	W
T _J	Operating Junction Temperature Range	-40 to 125	°C
T _{STG}	Storage Temperature Range	-40 to 150	°C
T _{LEAD}	Lead Soldering Temperature for 5 sec.	260	°C



SP6013A

Synchronous Rectifier Driver

THERMAL RESISTANCE

Symbol	Parameter	Value	Unit
$R_{\theta JC}$	Thermal Resistance Junction – Case (*)	45	$^{\circ}C/W$

(*) The power dissipation and thermal resistance are evaluated under copper board mounted with free air conditions.

ELECTRICAL CHARACTERISTICS

($T_A=25^{\circ}C$, $V_{dd}=12V$, Freq. =300 KHz, Duty Cycle=50%, unless otherwise specified.)

Symbol	Parameter	Conditions	Min.	Typ.	Max.	Unit
SUPPLY INPUT						
IDD	Supply current	No load		10	16	mA
		$V_{SYNC}=0V$, No load		7.5	10	mA
Vonh	Vdd turn on threshold			9.5	10	V
Voffh	Vdd turn off threshold		8	8.5		V
SYNC REFERENCE (SYNC)						
Vshth	SYNC high threshold		3.9	5.0		V
Vslth	SYNC low threshold			0.9	1.2	V
Isync	SYNC input current				3	mA
Voltage Regulator REFERENCE (VR)						
I _{VR}	VR Output Current				25	mA
ON TIME DUTY SETUP (PIN 6)						
Ton-time			10			us
MOSFET GATE DRIVER (MOSG-C)						
Voh	Output high voltage	$I_o = -200mA$	11.5	11.8		V
Vol	Output low voltage	$I_o = 200mA$		0.1	0.2	V
Td	Propagation delay	No load	15	35		ns
Tpred		No load		120		ns
Tr	Rise time	Load = 1nF (*)		10	25	ns
Tf	Fall time	Load = 1nF (*)		10	25	ns

(*) T_r & T_f are measured among 10% and 90% of starting and final voltage.

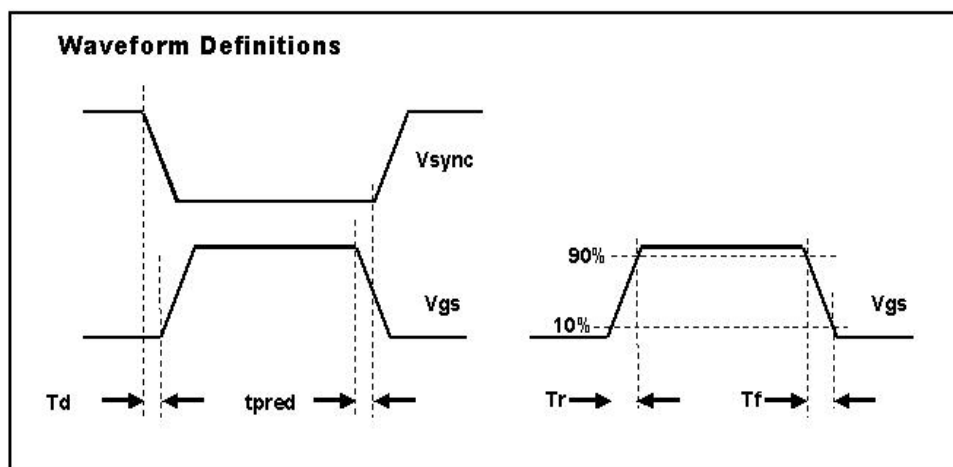



SP6013A

Synchronous Rectifier Driver

PERFORMANCE CHARACTERISTICS ($T_A=25^{\circ}\text{C}$, unless otherwise specified.)

Figure 1 : Supply Current vs Supply Voltage

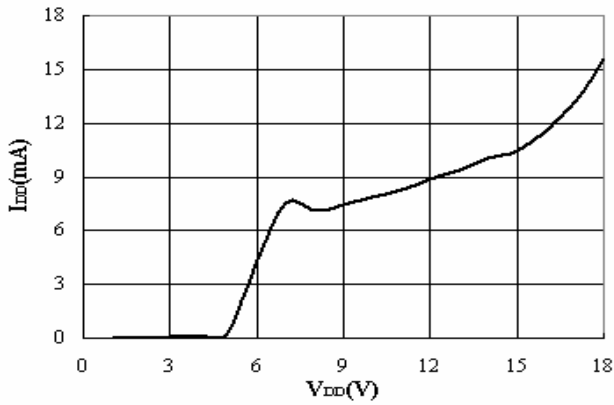

Figure 2 : Supply Current vs Freq. @ No Load

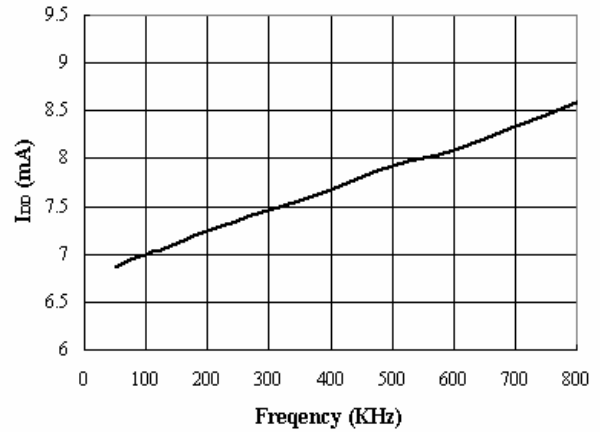

Figure 3 : T_{pred} vs C_{pred} @ Freq = 70 KHz ; $V_{DD}=10\text{V}$

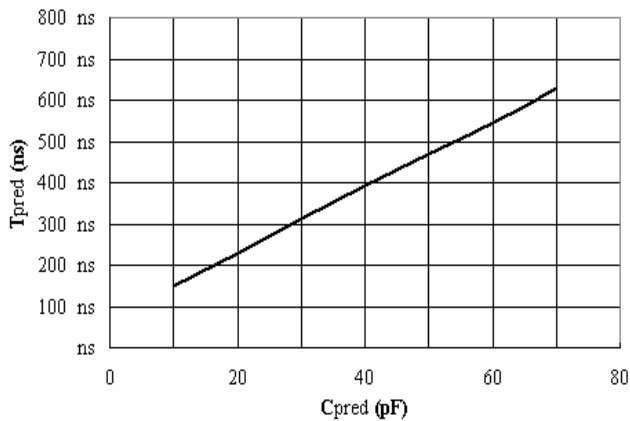

Figure 4 : Output Rise Time vs Load Capacitor

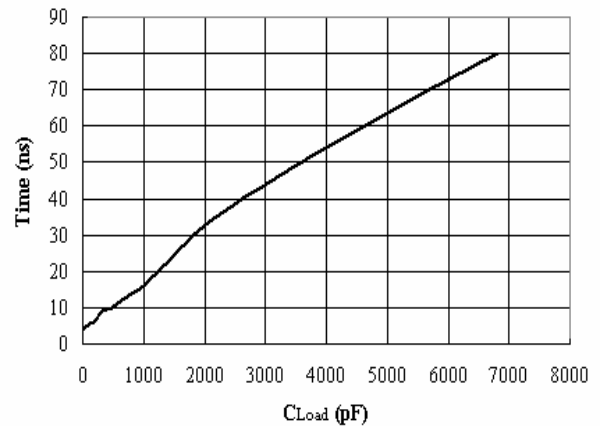

Figure 5 : Output Fall Time vs Load Capacitor

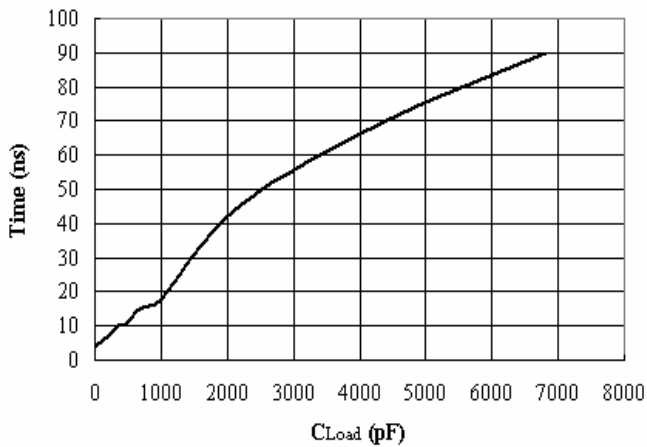
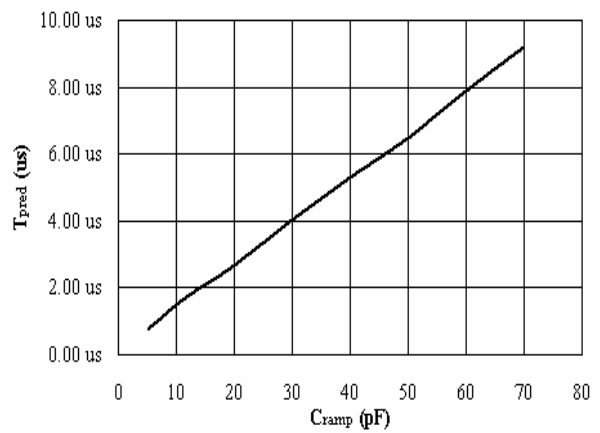

Figure 6 : T_{pred} vs C_{ramp} @ Freq = 20 KHz



*Fig. 1 : No Load ; No SYNC

*Fig. 4-5 : Frequency = 65 kHz.



SP6013A

Synchronous Rectifier Driver

SOP- 8 PACKAGE OUTLINE

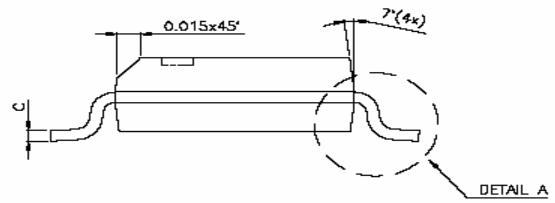
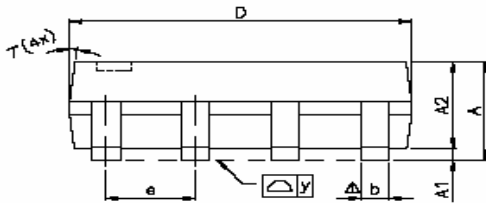
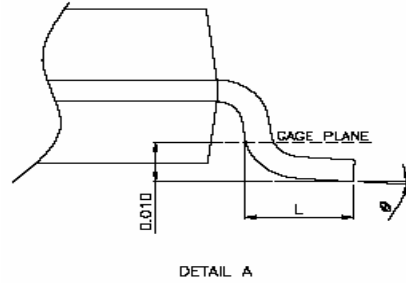
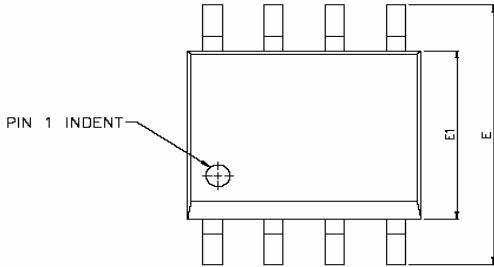

SYMBOLS	DIMENSIONS IN MILLIMETERS			DIMENSIONS IN INCHES		
	MIN	NOM	MAX	MIN	NOM	MAX
A	1.47	1.60	1.73	0.058	0.063	0.068
A1	0.10	—	0.25	0.004	—	0.010
A2	—	1.45	—	—	0.057	—
b	0.33	0.41	0.51	0.013	0.016	0.020
C	0.19	0.20	0.25	0.0075	0.008	0.0098
D	4.80	4.85	4.95	0.189	0.191	0.195
E	5.80	6.00	6.20	0.228	0.236	0.244
E1	3.80	3.90	4.00	0.150	0.154	0.157
e	—	1.27	—	—	0.050	—
L	0.38	0.71	1.27	0.015	0.028	0.050
∇y	—	—	0.076	—	—	0.003
θ	0°	—	8°	0°	—	8°



SP6013A

Synchronous Rectifier Driver

Information provided is alleged to be exact and consistent. SYNC Power Corporation presumes no responsibility for the penalties of use of such information or for any violation of patents or other rights of third parties, which may result from its use. No license is granted by allegation or otherwise under any patent or patent rights of SYNC Power Corporation. Conditions mentioned in this publication are subject to change without notice. This publication surpasses and replaces all information previously supplied. SYNC Power Corporation products are not authorized for use as critical components in life support devices or systems without express written approval of SYNC Power Corporation.

©The SYNC Power logo is a registered trademark of SYNC Power Corporation
©2004 SYNC Power Corporation – Printed in Taiwan – All Rights Reserved
SYNC Power Corporation
9F-5, No.3-2, Park Street
NanKang District (NKSP), Taipei, Taiwan, 115, R.O.C
Phone: 886-2-2655-8178
Fax: 886-2-2655-8468
<http://www.syncpower.com>