

PASS WORD SHINDENGEN

July.2005
Vol.05-07-e

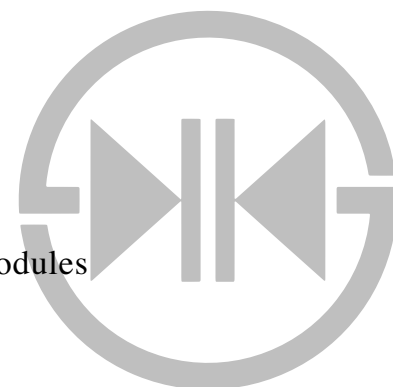

MR4000/5000 Series Partial Resonance Power Supply IC Modules Supporting Standby Mode Operation



Satoshi Okamoto

Device Design Department, Advanced Power Products
Division (joined Shindengen in 2002)

1 Introduction

As digital home appliances such as plasma TVs, LCD TVs, and digital audio components increase in performance and size, power output capacity is increasing. At the same time, environmental concerns are creating more demand for digital home appliances and other electronic devices with lower power consumption during standby, and higher efficiency during steady operation. The previously released models in Shindengen's MR Series of partial resonance power supply IC modules have a function for switching to standby mode during micro-loads. This paper describes the recently completed MR4000/5000 Series, designed for higher efficiency and higher power output capacity. (A model with a CoolMOS device is under development.)

2 Product Overview (see Figure 1)

The MR Series are partial resonance power supply IC modules with a function for switching to standby mode during micro-loads. They are comprised of a switching element and control IC optimized to 100 V class, 200 V class, and worldwide input power supplies. The MR4000/5000 Series reduce the control IC loss more than conventional products, and incorporate high-performance switching elements such as Shindengen's original second-generation high-speed IGBTs (insulated gate bipolar transistors) and CoolMOS* devices. These features reduce power consumption during micro-loads, and increase efficiency and power output capacity during heavy loads. (* The model with a CoolMOS device is under development.)

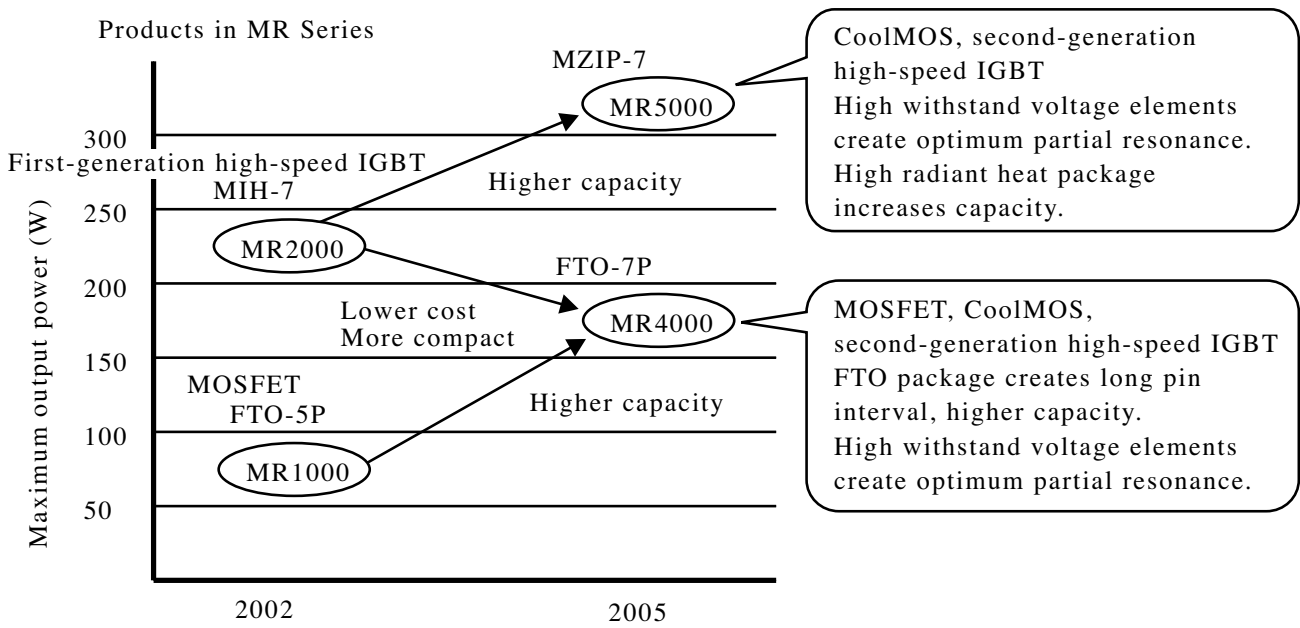

Figure 1. Products in MR Series

2-1 MR4000/5000 Series features

The MR4000/5000 Series incorporate the following main features.

- Use of second-generation high-speed IGBTs and CoolMOS devices improves efficiency.
- Reduction of control IC loss improves standby characteristic.
- Same control functions as predecessor MR2000 Series, enabling simple device design.
- Higher efficiency, low noise

The high-speed IGBTs developed by Shindengen are elements with an original patented structure. The first-generation high-speed IGBT was released in the MR2000 Series. The second-generation high-speed IGBT altered the internal structure of the first-generation model, improving on its saturation characteristic and tail loss tradeoff characteristic. These improvements further reduced the tail loss of the second-generation high-speed IGBT while maintaining the same saturation characteristic as the first-generation model.

Figure 2 compares the tail loss waveform of the first- and second-generation high-speed IGBTs. After subtracting a 10 μJ loss (corresponding to the junction capacitance), the tail loss is reduced by roughly half, from 77 to 39 μJ .

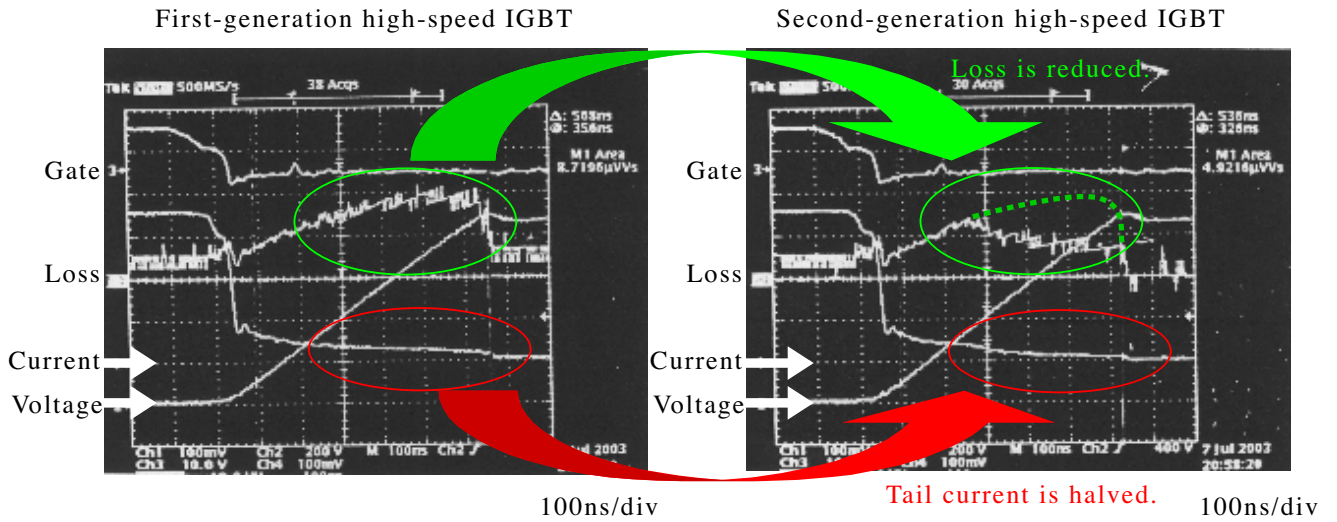

Figure 2 Tail loss waveforms of first- and second-generation high-speed IGBTs

Next, we compared the temperature rise versus input voltage characteristics of the first- and second-generation high-speed IGBTs, with a worldwide input ($P_o = 100\text{ W}$) power supply, and the same chip size and package (see Figure 3). The second-generation model reduces the temperature rise by at least 8°C when V_{in} is 276 VAC.

This improvement increases the capacity to a value much higher than the MR1000/2000 Series. The MR4000 Series has a P_o value of 180 W with an FTO-7P package, and the MR5000 Series a P_o value of 320 W with an MZIP-7 package. (Reference: Maximum output capacity values of previous models are $P_o = 80\text{ W}$ for the MR1000 Series (FTO-5P package), and $P_o = 250\text{ W}$ for the MR2000 Series (MIH-7 package).)

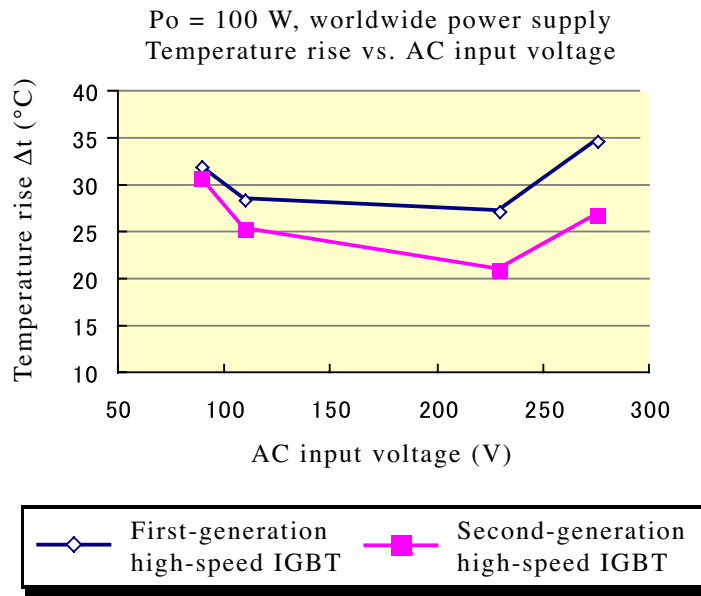

Figure 3 Temperature rise vs. input voltage

Standby power has been reduced by optimizing the startup circuit's bias current. We compared the standby mode input power of MR4010 and MR1722 with a worldwide input ($P_o = 25\text{ W}$) power supply. When V_{in} was 100 VAC, the no-load input power (P_{in}) was 74 mW (MR1722) and 62 mW (MR4010) (see Figure 4-1). When V_{in} was 230 VAC, P_{in} was 120 mW (MR1722) and 85 mW (MR4010) (see Figure 4-2). The improvement in input power was particularly significant with 200 V AC class input, where there was a 35 mW reduction during no load.

[Power supply specifications for comparison: $V_{in} = 85$ to 276 VAC; 5/12 V output ($P_o = 25\text{ W}$ (peak 45 W)) power supply]

Note: Only 5 V output was used for output power in standby mode (12 V output 0 A).

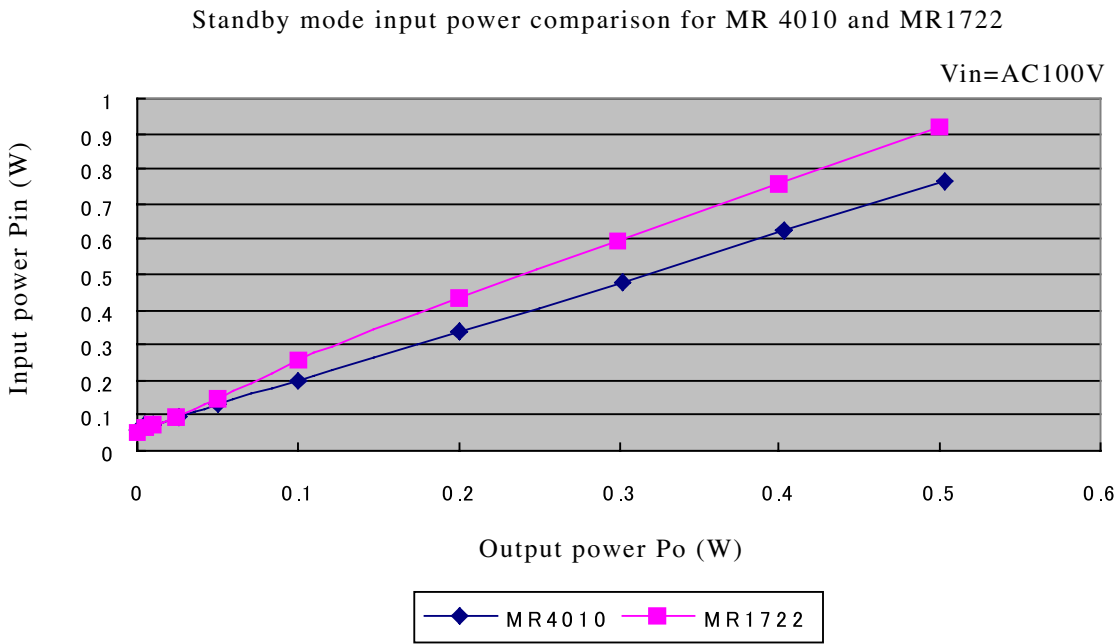

Figure 4-1 Standby mode input power comparison for MR 4010 and MR1722 (1) ($V_{in} = 100\text{ VAC}$)

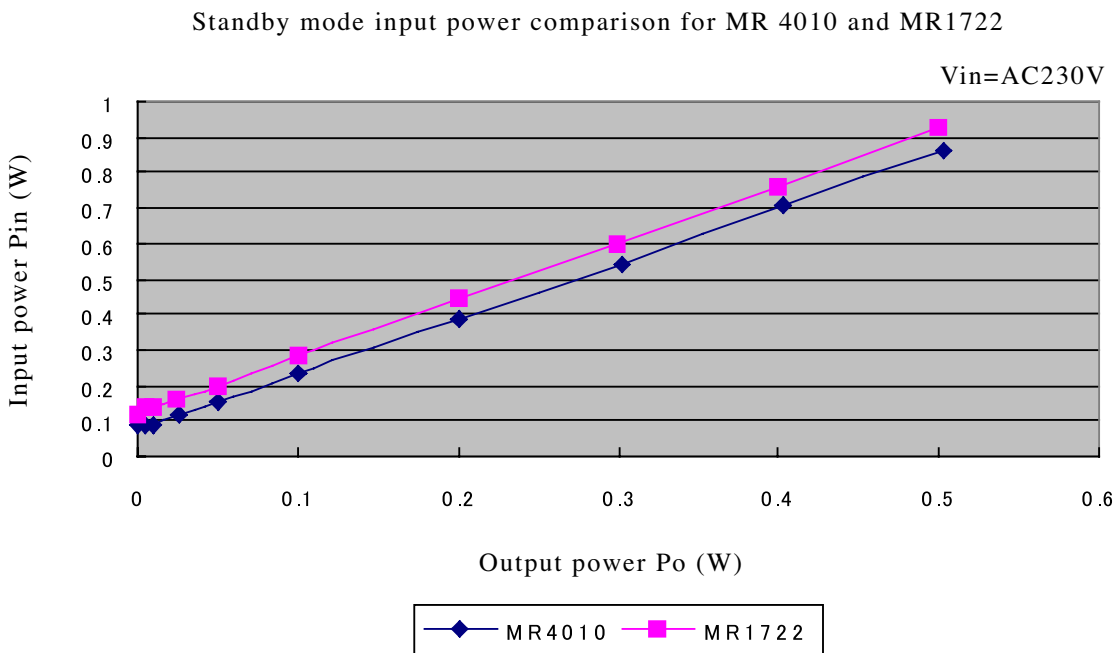

Figure 4-2 Standby mode input power comparison for MR 4010 and MR1722 (2) ($V_{in} = 230\text{ VAC}$)

2-2 Product range

Table 1 shows the MR4000/5000 Series products. The maximum output capacity and input voltage ranges differ according to the design conditions.

Model name	Main switching element	Maximum output capacity Po (W) (reference value)			
		Withstand voltage (V)	Input voltage ranges		
			AC90 ~ 132V	AC180 ~ 276V	AC90 ~ 276V
MR4500	MOSFET	500	12	-	-
MR4510			25	-	-
MR4520			50	-	-
MR4530			80	-	-
MR4710		700	-	25	12
MR4720			-	50	25
MR4010	Second-generation high-speed IGBT	900	-	70	45
MR4020			-	105	70
MR4030			-	135	90
MR4040			-	180	120
MR5540 ※	MOSFET	500	150	-	-
MR5650 ※	CoolMOS	600	200	-	-
MR5040	Second-generation high-speed IGBT	900	-	270	150
MR5060			-	320	180

Table 1. MR4000/5000 Series products

※ Under development

2-3 Individual product features

The main features of products in the MR4000/5000 Series are described below.

MR4000 Series features

(1) Higher output capacity with FTO package

(Po for MR1531 [FTO-5P] = up to 80 W → MR4040 [FTO-7P] = up to 180 W)

(2) FTO package 7-pin configuration allows for distance between high-voltage pins.

(3) Use of second-generation high-speed IGBT with 900 V withstand voltage improves efficiency.

(4) Supports standby mode (Pin at no load is about 60 mW).

Applications: DVD recorders, LCD TVs, digital set top boxes, multifunction printers, white goods, other

MR5000 Series features

(1) Achieves higher output capacity with new MZIP-7 package.

(Po for MR5060 [MZIP-7] = up to 320 W)

(2) New high radiant heat package allows for distance between high-voltage pins.

(3) Use of CoolMOS and second-generation high-speed IGBT improves efficiency.

(4) Supports standby mode (Pin at no load is about 100 mW).

Applications: Plasma TVs, LCD TVs, digital audio, other

This section presents efficiency data for power supplies with MR4030/5060.

3-1 MR4030

We compared the efficiency of MR4030 and MR2920 in a worldwide input 24 V single output ($P_o = 90\text{ W}$) power supply. Figure 5 shows the efficiency data when V_{in} is 220 and 276 VAC. The peak efficiency value when V_{in} was 220 VAC was 90.1%. MR4030 improved efficiency by a maximum of about 1.7% over MR2920. (Note: MR2920 uses the first-generation high-speed IGBT and MIH-7 package, and has a maximum output capacity (P_o) of up to 100 W for worldwide input.)

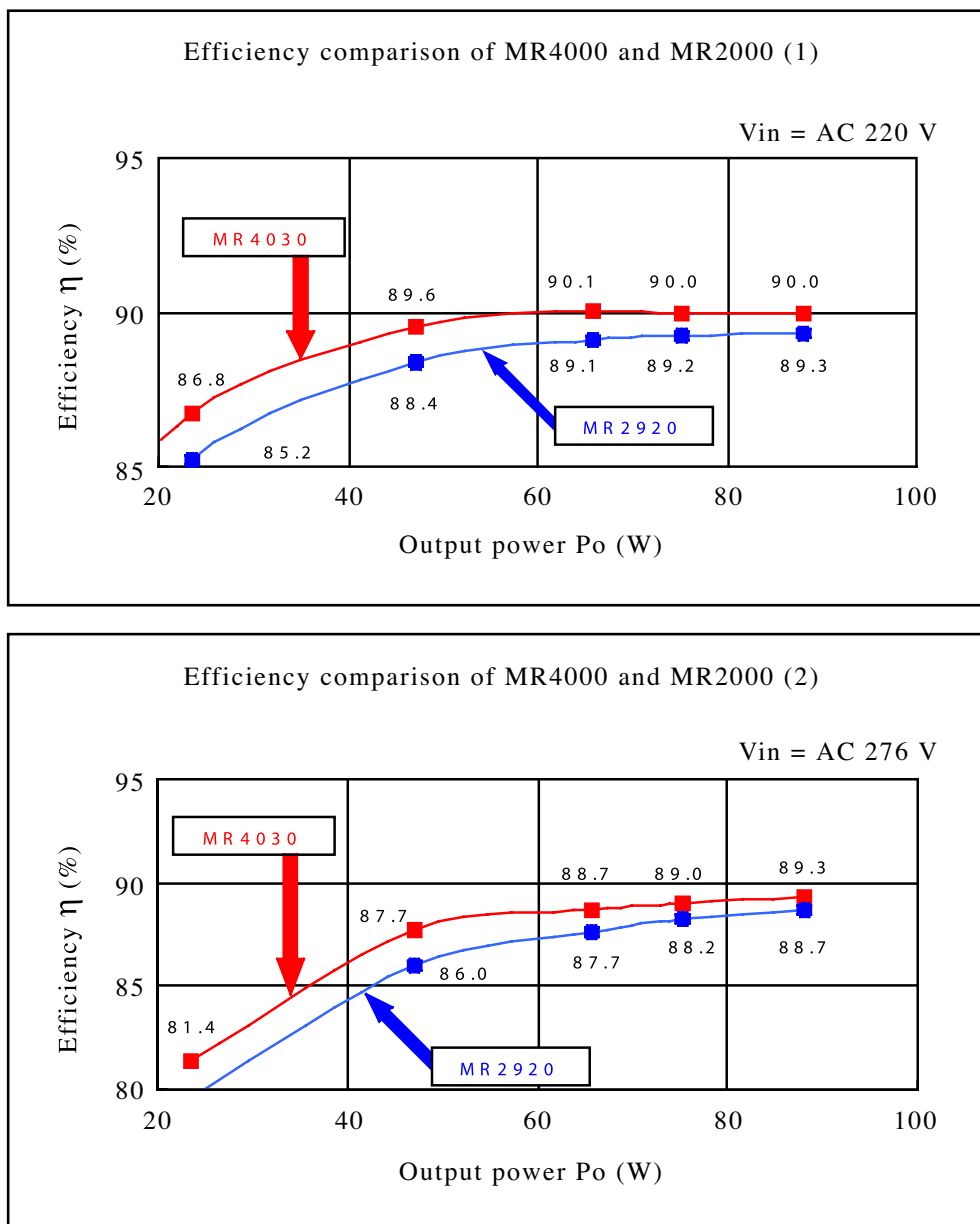
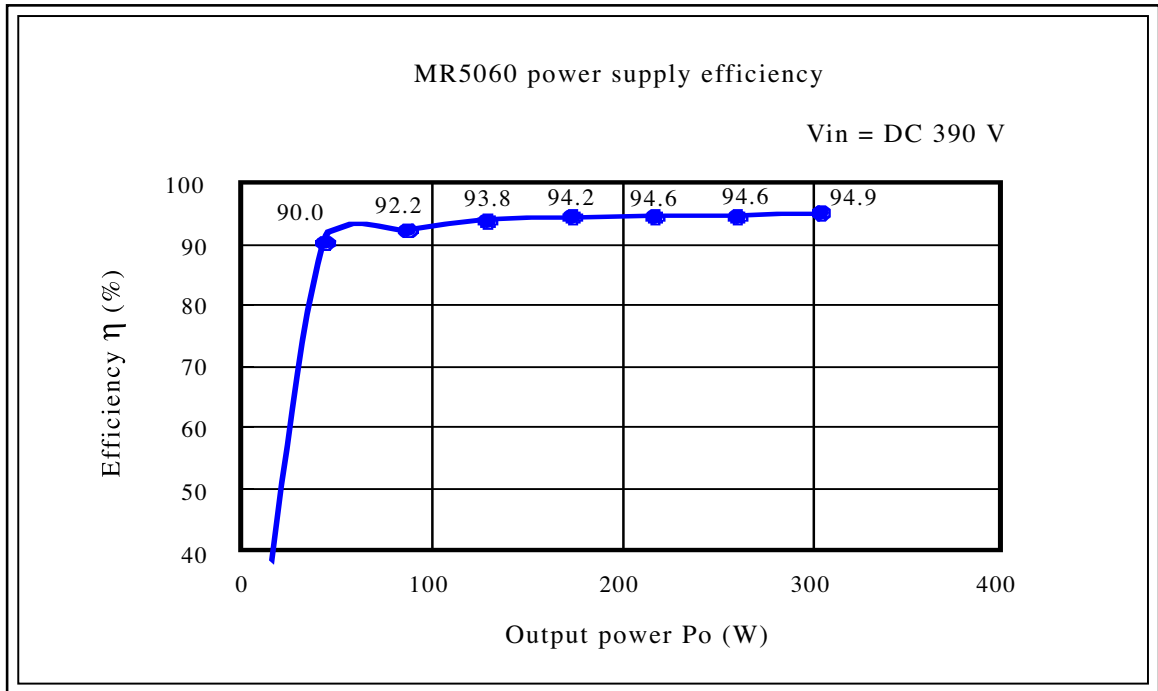

Figure 5 Efficiency comparisons of MR4030 and MR2920

Figure 6 shows the efficiency data of a power supply using MR5060. Despite being a partial resonance power supply using RCC, it had a peak efficiency value of 94.9%.



[Power supply specifications: 390 VDC input (modeling stage after power factor correction in a power supply with PFC), 87 V single-output, 320 W power supply]

Figure 6 MR5060 power supply efficiency

4 Product Photographs, Equivalent Circuits

Figures 7 and 8 show photographs of MR4000/5000 Series models and their equivalent circuits.

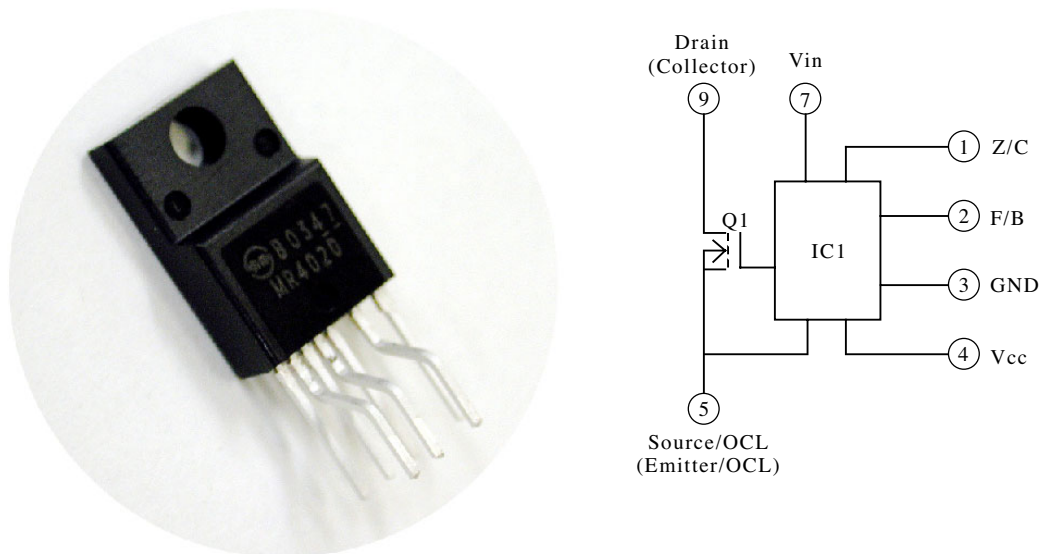

Figure 7 Photo of MR4000 Series model and its equivalent circuit

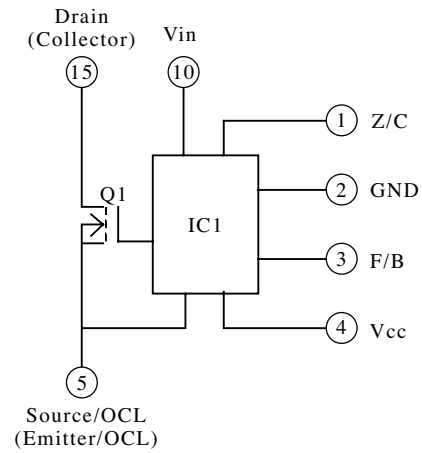
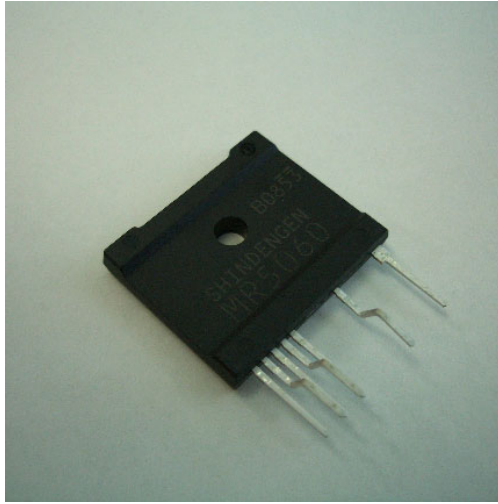

Figure 8 Photo of MR5000 Series model and its equivalent circuit

The table below lists pin names and functions.

Pin name	Function
Z/C	Sets the ON timing. Sets the signal from the control coil with the CR time constant. Clamping the Z/C pin to 4.1 V (typical) or less with a photocoupler, etc. selects standby mode.
F/B	Controls the ON width with the pin voltage. The resistor setting the maximum ON width and the feedback photocoupler are connected to this pin.
GND	Ground pin
Vcc	Supplies power from the control coil.
Vin	Directly inputs the AC voltage rectified by the startup circuit. Supplies current to Vcc only at startup, and automatically shuts off after startup.
Source/OCL (Emitter/OCL)	The current detection resistor is connected to the source/OCL (emitter/OCL) pin.
Drain(Collector)	The drain (collector) pin for the main switch

Items in parentheses () are for MR40xx and MR50xx models.

5 Conclusion

The MR4000/5000 Series have better switching elements and control ICs than previous models (MR1000/2000 Series), and package changes have enabled higher efficiency and higher capacity. Switching power supplies will always demand lower power consumption during standby and more compact models (fewer parts). Customer demands are also becoming more diverse as applications such as digital home appliances and white goods expand. In the years ahead, Shindengen plans to create control ICs with more advanced functions and expand our product series to provide products more closely meeting customer needs.

Note: CoolMOS is a registered trademark of Infineon Technologies AG.

MR4000/5000 Series inquiries
Sales Planning Office, Sales Department
Tel: +81-3-3279-4464